

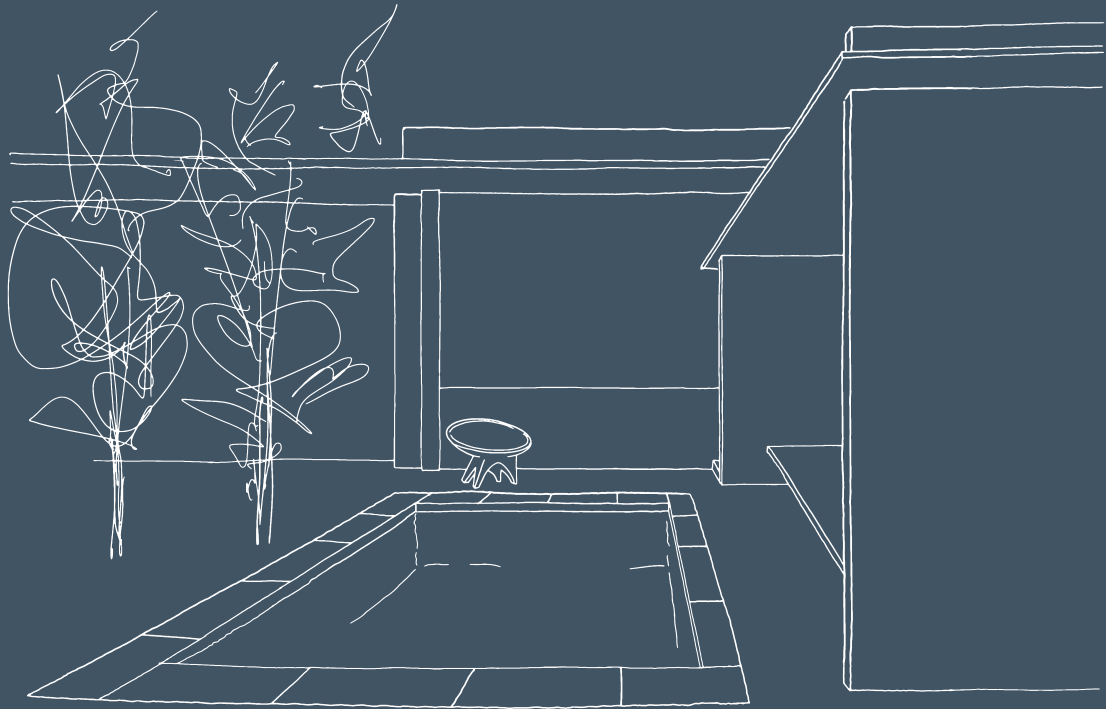

atlas concorde
U S A

Interactive version



Outdoor Pavers 2024

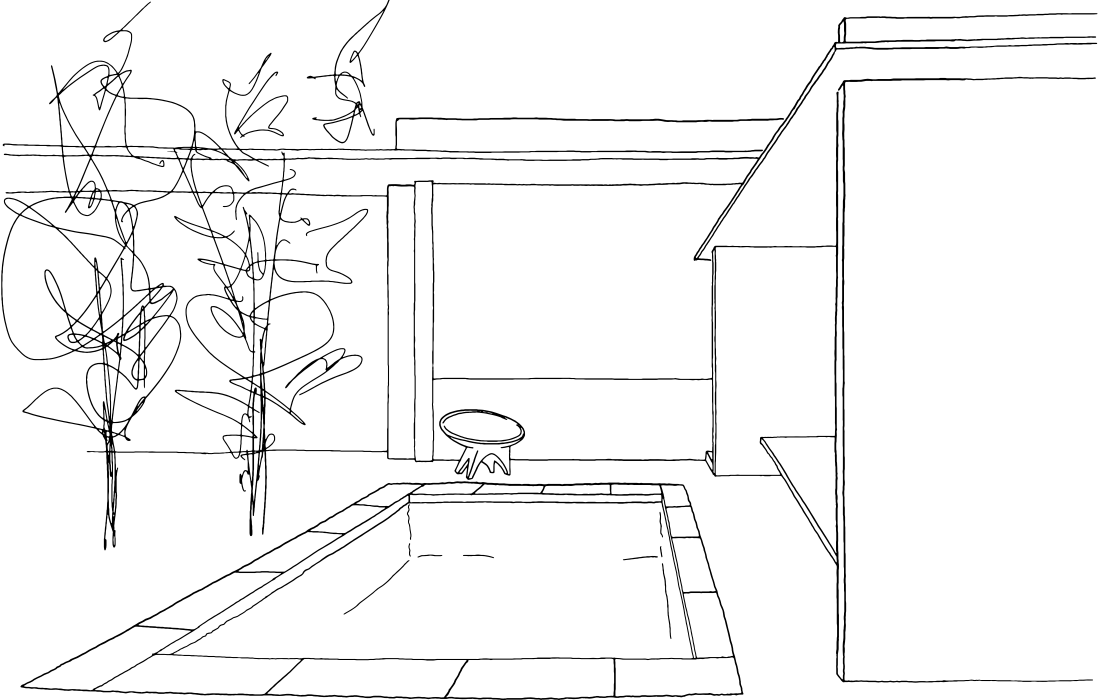

Outdoor Pavers 2024



Index

Product Finder	
Look Index	05
Surface Range	06
Benefits of Outdoor Pavers	08
Sensitech	09
Products	10
Pro Resources	50
Information & Inspiration	52
Merchandising	54
Technical Specifications	56
Installation Methods	58
Technical Information	60
Trims Tiles	62
Environmental Sustainability	64
Certifications	65
Technical Specifications	66
Color Shading	67
Tile Packaging	68
Merchandising Packaging	68
General Sales Conditions	69



Look Index

Concrete Look	12	MARK CHROME
Marble Look	14	BEYOND DOLOMITE WARM WHITE new
Stone Look	16	BLOCK BIANCO
	18	BLUESTONE SELECT
	20	BOOST STONE CREAM new
	22	BOOST STONE WHITE new
	24	BRAVE GRAY
	26	BRAVE GYPSUM
	28	BRAVE PEARL
	30	FIOR DI BOSCO GRAY new
	32	FLAGSTONE SELECT new
	34	HERO SILVER new
	36	HERO SNOW new
	38	SEASTONE GRAY
	40	TRUST GOLD
	42	TRUST SILVER
Wood Look	48	AXI WHITE PINE
	44	AXI BROWN CHESTNUT
	46	AXI GRAY TIMBER



atlasconcordeusa.com >
DOWNLOAD OUTDOOR CATALOG

PRODUCT FINDER >

Look Index

Surface Range

Benefits of Outdoor Pavers

Sensitech

PRODUCTS >

PRO RESOURCES >

TECHNICAL SPECIFICATIONS >

Outdoor Pavers

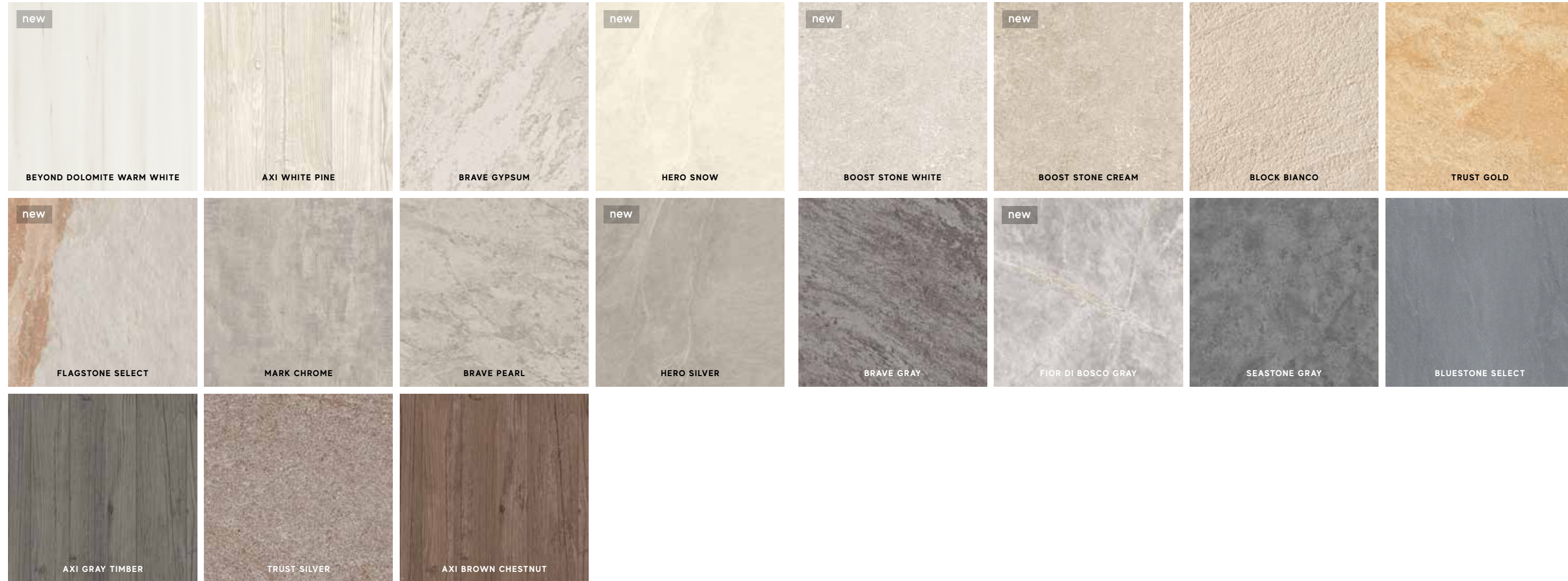

PRODUCT FINDER >

Look Index

Surface Range

Benefits of Outdoor Pavers

Sensitech

PRODUCTS >

PRO RESOURCES >

TECHNICAL SPECIFICATIONS >

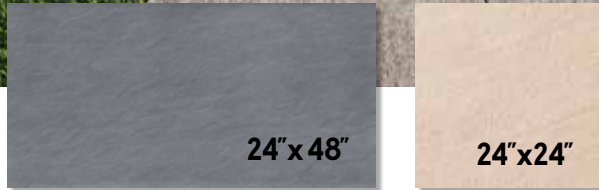
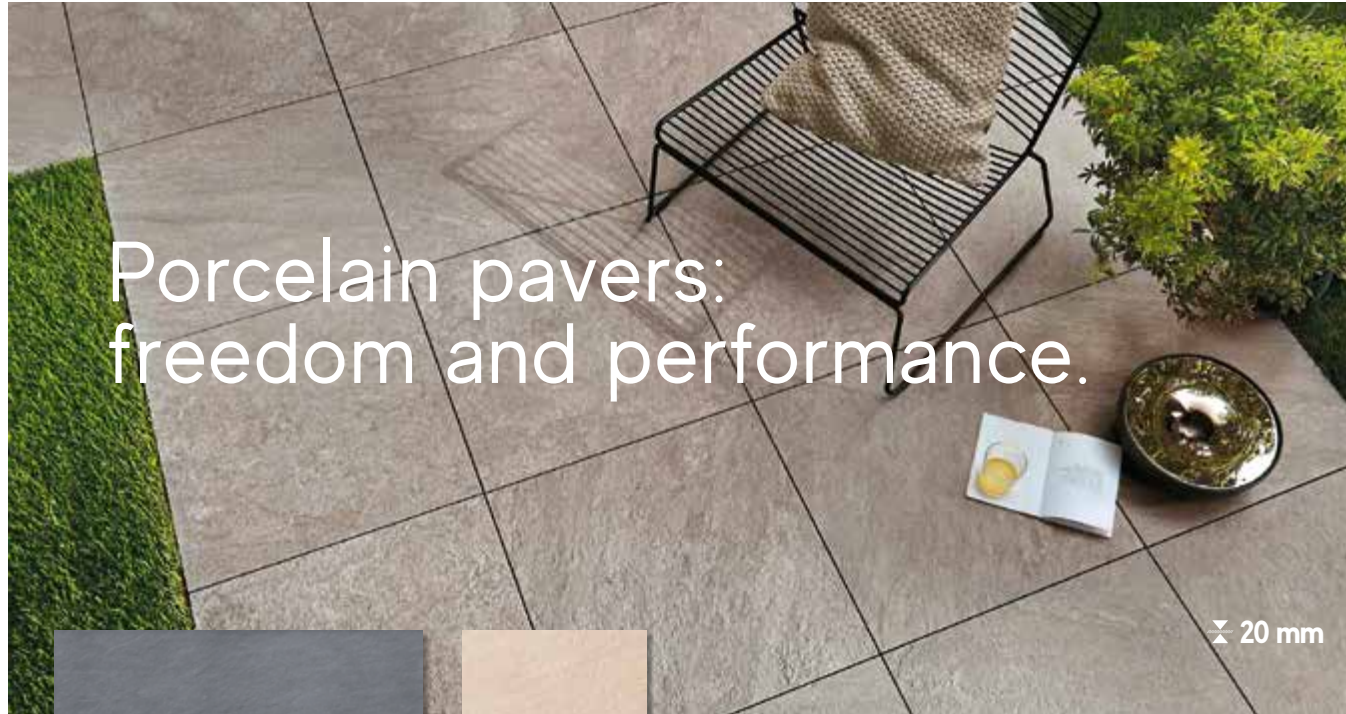



Create the perfect outdoor environment with Atlas Concorde USA porcelain pavers.

At 20mm thick, pavers combine maximum freedom of style and excellent performance for landscaping, patios, pools and urban design. With high breaking strength, weather resistance, and anti-slip properties, these Made in USA products will elevate your next outdoor project. Explore all the looks including concrete, marble, stone and wood.

- 

High breaking strength
- 

Resistant to fading, mold and moss
- 

Excellent anti-slip
- 

Weather resistant



NOW OFFERED FOR OUR ENTIRE PAVER RANGE.

Sensitech, the highly innovative porcelain tile surface technology developed by Atlas Concorde labs to offer a high level of safety against slipping, easy cleaning, and comfort, has been extended to all Made in USA pavers.

Sensitech guarantees non-slip properties in compliance with international requirements, giving the surface a softness that makes it pleasant to the touch compared with traditional non-slip surfaces.



To Learn More Contact Us at: <https://www.atlasconcordeusa.com/en/contacts/>



4-in-1

Anti-Slip 

Soft to the touch 

Easy to clean 

Patent Pending 

Products

Concrete Look	Mark Chrome	12
Marble Look	Beyond Dolomite Warm White	14
Stone Look	Block Bianco	16
	Bluestone Select	18
	Boost Stone Cream	20
	Boost Stone White	22
	Brave Gray	24
	Brave Gypsum	26
	Brave Pearl	28
	Fior Di Bosco Gray	30
	Flagstone Select	32
	Hero Silver	34
	Hero Snow	36
	Seastone Gray	38
	Trust Gold	40
Trust Silver	42	
Wood Look	Axi Brown Chestnut	44
	Axi Gray Timber	46
	Axi White Pine	48

PRODUCT FINDER >

PRODUCTS >

CONCRETE LOOK

Mark chrome

MARBLE LOOK

Beyond Dolomite Warm White New

STONE LOOK

Block Bianco

Bluestone Select

Boost Stone Cream New

Boost Stone White New

Brave Gray

Brave Gypsum

Brave Pearl

Fior Di Bosco Gray New

Flagstone Select New

Hero Silver New

Hero Snow New

Seastone Gray

Trust Gold

Trust Silver

WOOD LOOK

Axi White Pine

Axi Brown Chestnut

Axi Gray Timber

PRO RESOURCES >

TECHNICAL SPECIFICATIONS >

Mark Chrome

Outdoor Sensitech \pm 20 mm



DCOF \geq 0.60 Wet Exterior Wet (EW)



V2 Slight Variation



MADE IN USA



24"x48"
610010004671 Mark Chrome

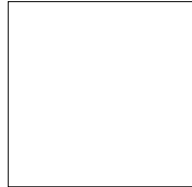

24"x24"
600010009002 Mark Chrome

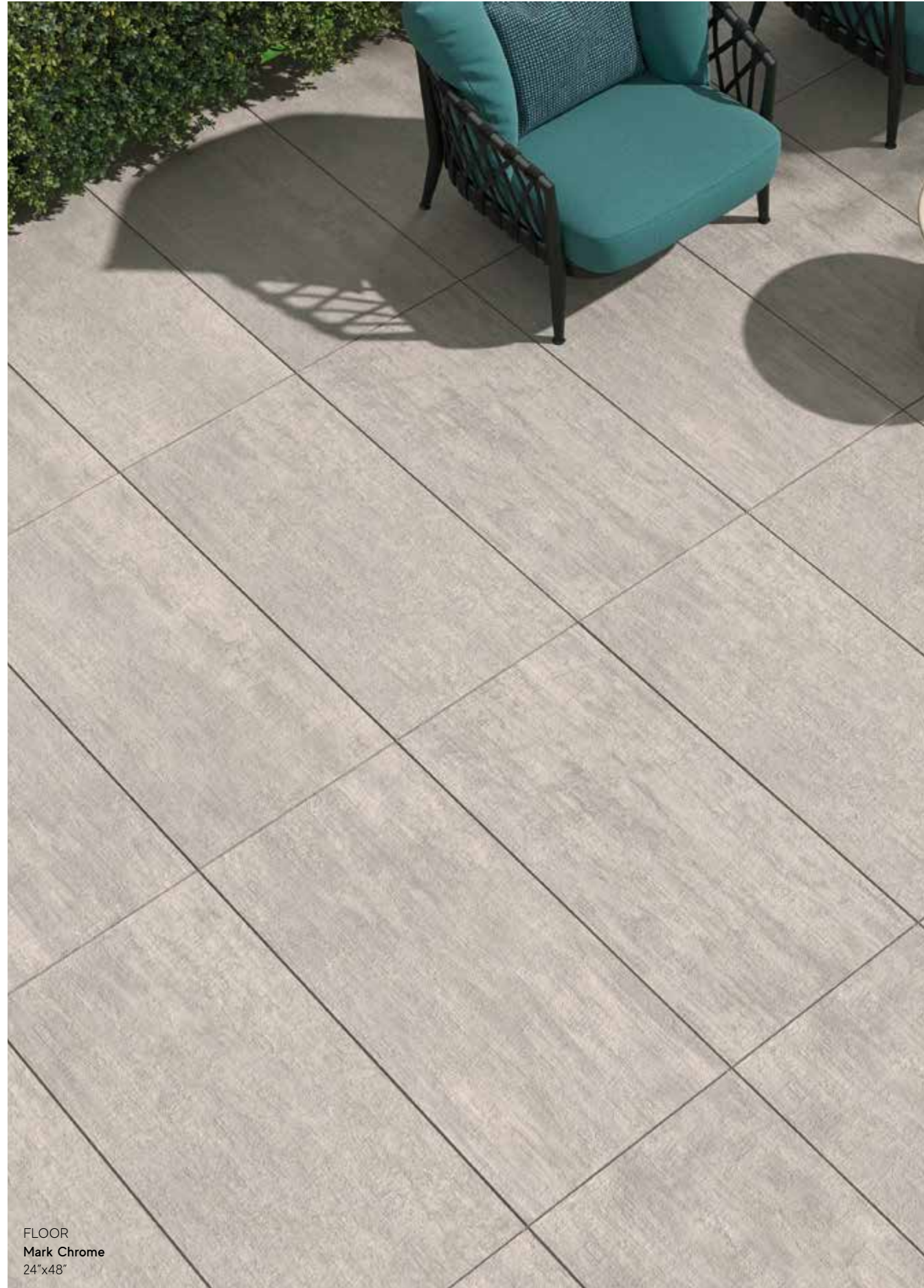

FLOOR
Mark Chrome
24"x48"



PRODUCT FINDER >

PRODUCTS >

CONCRETE LOOK

Mark Chrome

MARBLE LOOK

Beyond Dolomite Warm White New

STONE LOOK

Block Bianco

Bluestone Select

Boost Stone Cream New

Boost Stone White New

Brave Gray

Brave Gypsum

Brave Pearl

Fior Di Bosco Gray New

Flagstone Select New

Hero Silver New

Hero Snow New

Seastone Gray

Trust Gold

Trust Silver

WOOD LOOK

Axi White Pine

Axi Brown Chestnut

Axi Gray Timber

PRO RESOURCES >

TECHNICAL SPECIFICATIONS >

Beyond Dolomite Warm White

Outdoor Sensitech \pm 20 mm



DCOF \geq 0.60 Wet Exterior Wet (EW)



V2 Slight Variation



MADE IN USA

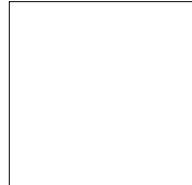

24"x24"
610010005660 Beyond Dolomite Warm White



FLOOR
Beyond Dolomite Warm White
24" x24"

PRODUCT FINDER >

PRODUCTS >

CONCRETE LOOK
Mark Chrome

MARBLE LOOK

Beyond Dolomite Warm White New

STONE LOOK

- Block Bianco
- Bluestone Select
- Boost Stone Cream New
- Boost Stone White New
- Brave Gray
- Brave Gypsum
- Brave Pearl
- Fior Di Bosco Gray New
- Flagstone Select New
- Hero Silver New
- Hero Snow New
- Seastone Gray
- Trust Gold
- Trust Silver

WOOD LOOK

- Axi White Pine
- Axi Brown Chestnut
- Axi Gray Timber

PRO RESOURCES >

TECHNICAL SPECIFICATIONS >

Block Bianco

Outdoor Sensitech \pm 20 mm



DCOF \geq 0.60 Wet Exterior Wet (EW)



V2 Slight Variation



MADE IN USA

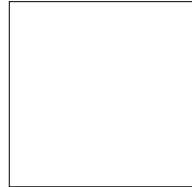

24"x24"
600010001912 Block Bianco



FLOOR
Block Bianco
24" x24"

PRODUCT FINDER >

PRODUCTS >

CONCRETE LOOK

Mark Chrome

MARBLE LOOK

Beyond Dolomite Warm White New

STONE LOOK

Block Bianco

Bluestone Select

Boost Stone Cream New

Boost Stone White New

Brave Gray

Brave Gypsum

Brave Pearl

Fior Di Bosco Gray New

Flagstone Select New

Hero Silver New

Hero Snow New

Seastone Gray

Trust Gold

Trust Silver

WOOD LOOK

Axi White Pine

Axi Brown Chestnut

Axi Gray Timber

PRO RESOURCES >

TECHNICAL SPECIFICATIONS >

Bluestone Select

Outdoor Sensitech \pm 20 mm



DCOF \geq 0.60 Wet Exterior Wet (EW)



V2 Slight Variation



MADE IN USA



24"x48"
610010004672 Bluestone Select

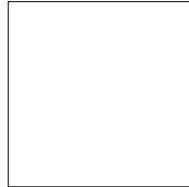

24"x24"
610010004761 Bluestone Select



FLOOR
Bluestone Select
24"x48"

PRODUCT FINDER >

PRODUCTS >

CONCRETE LOOK

Mark Chrome

MARBLE LOOK

Beyond Dolomite Warm White New

STONE LOOK

Block Bianco

Bluestone Select

Boost Stone Cream New

Boost Stone White New

Brave Gray

Brave Gypsum

Brave Pearl

Fior Di Bosco Gray New

Flagstone Select New

Hero Silver New

Hero Snow New

Seastone Gray

Trust Gold

Trust Silver

WOOD LOOK

Axi White Pine

Axi Brown Chestnut

Axi Gray Timber

PRO RESOURCES >

TECHNICAL SPECIFICATIONS >

Boost Stone Cream

Outdoor **Sensitech** \approx 20 mm

DCOF \geq 0.60 Wet Exterior Wet (EW)

V2 Slight Variation

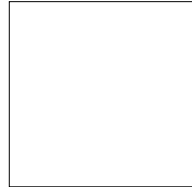

24"x24"
610010005526 Boost Stone Cream

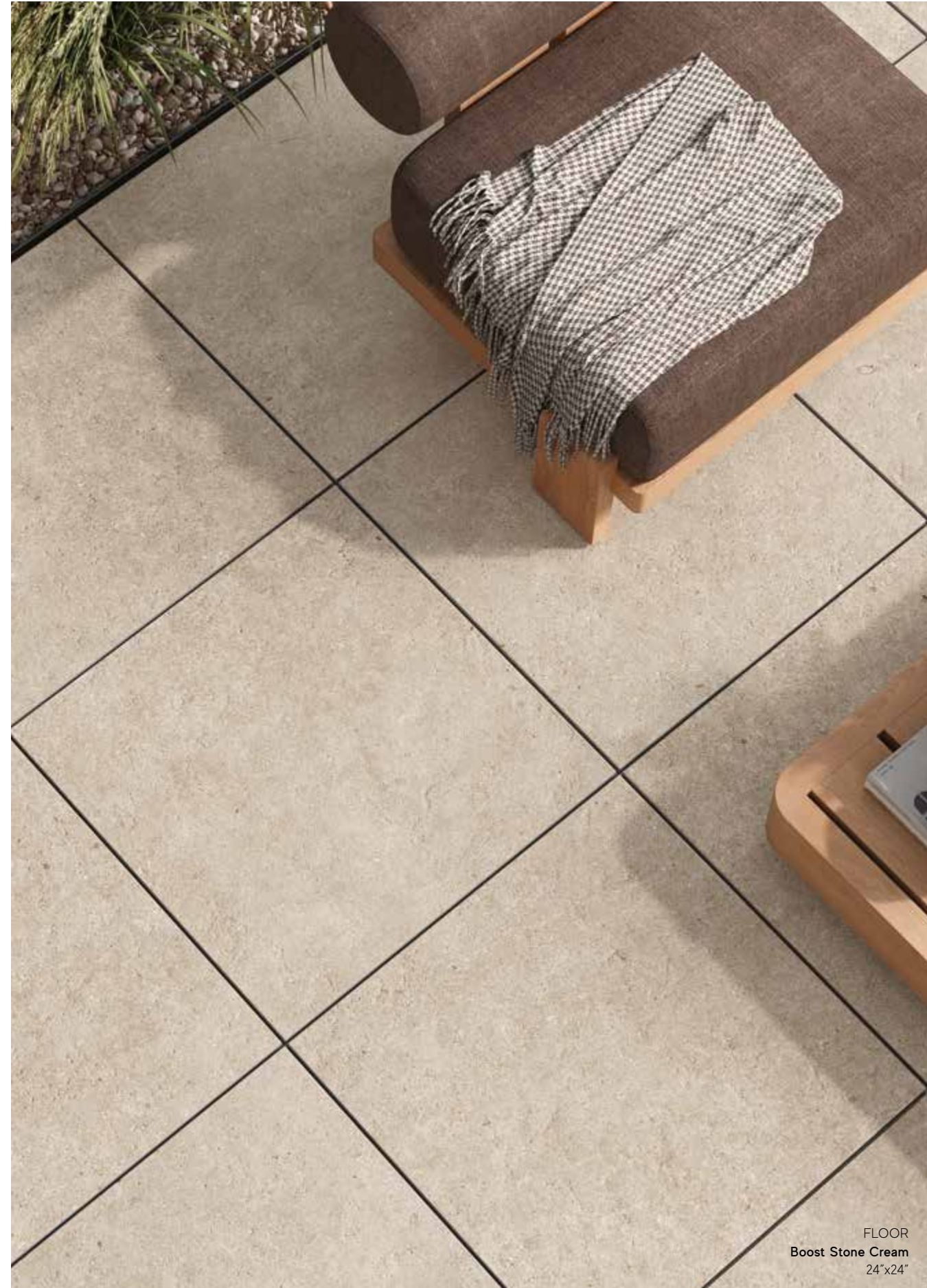

FLOOR
Boost Stone Cream
24"x24"

PRODUCT FINDER >

PRODUCTS >

CONCRETE LOOK
Mark Chrome

MARBLE LOOK
Beyond Dolomite Warm White New

STONE LOOK
Block Bianco
Bluestone Select

Boost Stone Cream New

Boost Stone White New

Brave Gray

Brave Gypsum

Brave Pearl

Fior Di Bosco Gray New

Flagstone Select New

Hero Silver New

Hero Snow New

Seastone Gray

Trust Gold

Trust Silver

WOOD LOOK

Axi White Pine

Axi Brown Chestnut

Axi Gray Timber

PRO RESOURCES >

TECHNICAL SPECIFICATIONS >

Boost Stone White

Outdoor Sensitech \approx 20 mm



DCOF \geq 0.60 Wet Exterior Wet (EW)



V2 Slight Variation



MADE IN USA

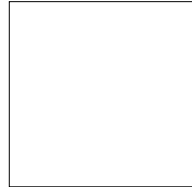

24"x24"
610010005571 Boost Stone White

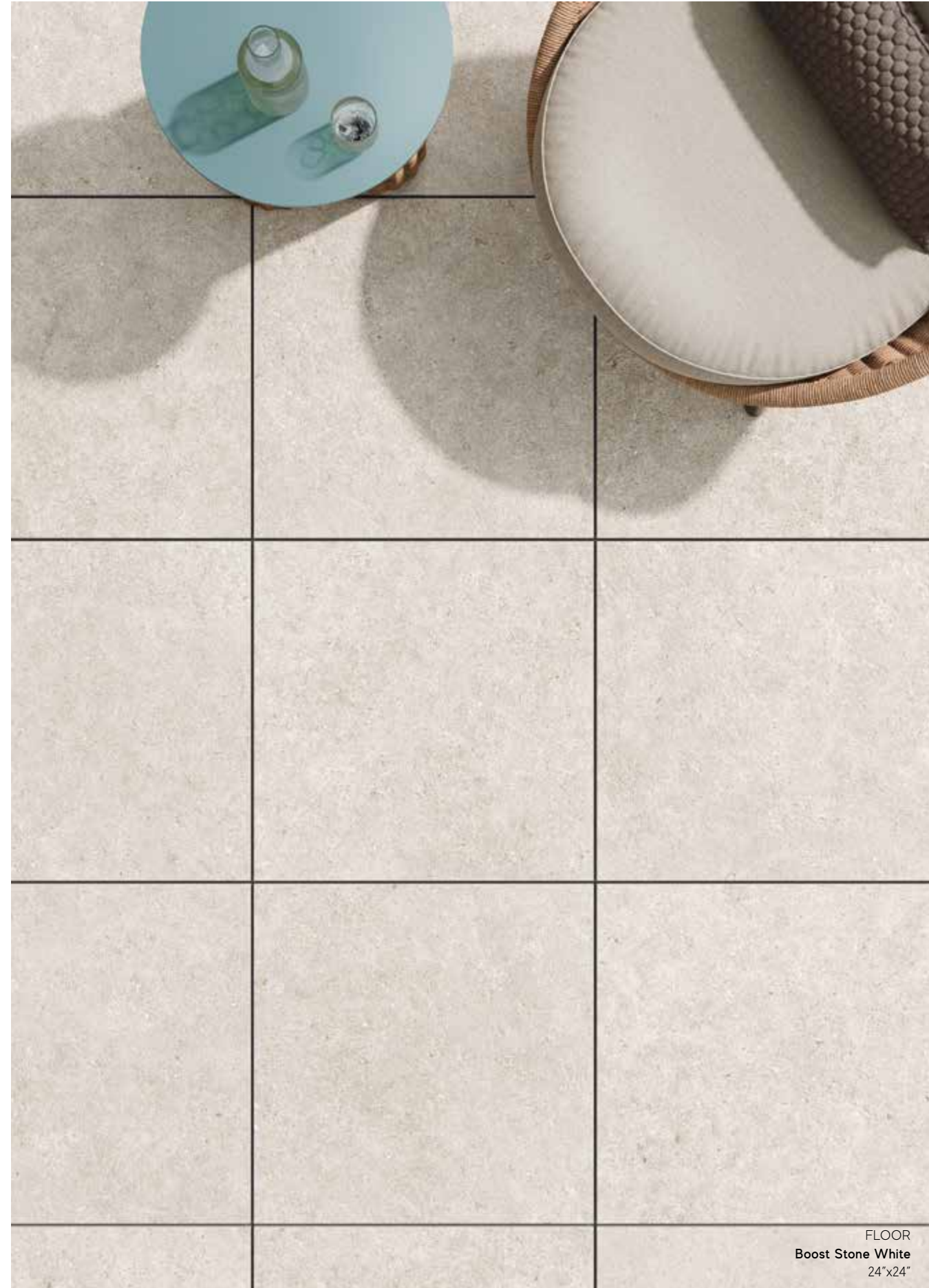

FLOOR
Boost Stone White
24"x24"

PRODUCT FINDER >

PRODUCTS >

CONCRETE LOOK
Mark Chrome

MARBLE LOOK
Beyond Dolomite Warm White New

STONE LOOK
Block Bianco
Bluestone Select
Boost Stone Cream New

Boost Stone White New

Brave Gray

Brave Gypsum

Brave Pearl

Fior Di Bosco Gray New

Flagstone Select New

Hero Silver New

Hero Snow New

Seastone Gray

Trust Gold

Trust Silver

WOOD LOOK

Axi White Pine

Axi Brown Chestnut

Axi Gray Timber

PRO RESOURCES >

TECHNICAL SPECIFICATIONS >

Brave Gray

Outdoor Sensitech \approx 20 mm



DCOF \geq 0.60 Wet Exterior Wet (EW)



V2 Slight Variation



MADE IN USA

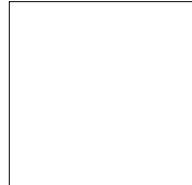

24"x24"
600010001910 Brave Gray

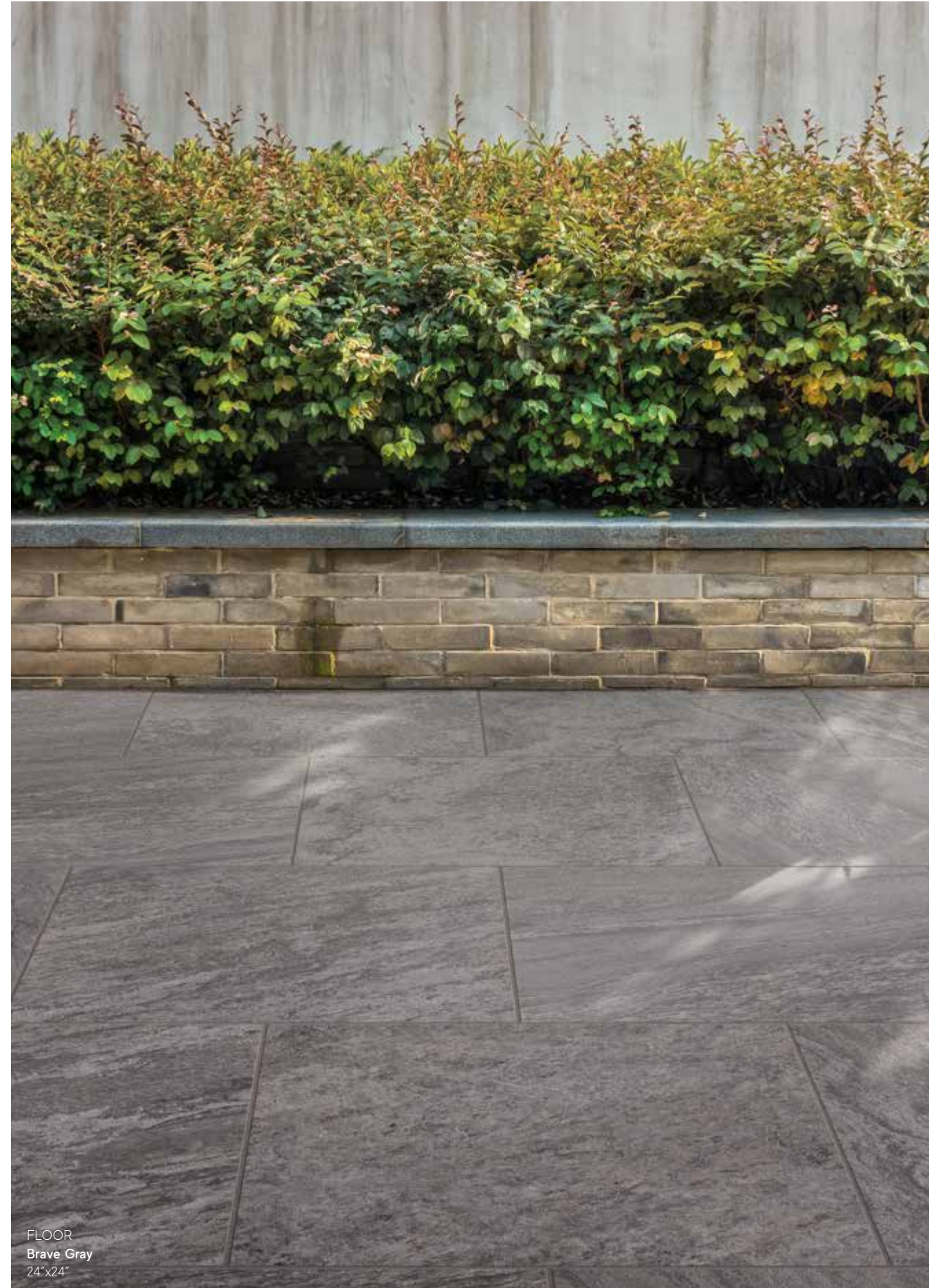

FLOOR
Brave Gray
24"x24"

PRODUCT FINDER >

PRODUCTS >

CONCRETE LOOK

Mark Chrome

MARBLE LOOK

Beyond Dolomite Warm White New

STONE LOOK

Block Bianco

Bluestone Select

Boost Stone Cream New

Boost Stone White New

Brave Gray

Brave Gypsum

Brave Pearl

Fior Di Bosco Gray New

Flagstone Select New

Hero Silver New

Hero Snow New

Seastone Gray

Trust Gold

Trust Silver

WOOD LOOK

Axi White Pine

Axi Brown Chestnut

Axi Gray Timber

PRO RESOURCES >

TECHNICAL SPECIFICATIONS >

Brave Gypsum

Outdoor Sensitech ✕ 20 mm

DCOF ≥ 0.60 Wet Exterior Wet (EW)

V2 Slight Variation

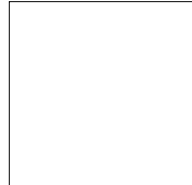

24"x24"
600010001911 Brave Gypsum



FLOOR
Brave Gypsum
24"x24"

PRODUCT FINDER >

PRODUCTS >

CONCRETE LOOK
Mark Chrome

MARBLE LOOK
Beyond Dolomite Warm White New

STONE LOOK
Block Bianco
Bluestone Select
Boost Stone Cream New
Boost Stone White New
Brave Gray

Brave Gypsum
Brave Pearl
Fior Di Bosco Gray New
Flagstone Select New
Hero Silver New
Hero Snow New
Seastone Gray
Trust Gold
Trust Silver

WOOD LOOK
Axi White Pine
Axi Brown Chestnut
Axi Gray Timber

PRO RESOURCES >

TECHNICAL SPECIFICATIONS >

Brave Pearl

Outdoor Sensitech \approx 20 mm

DCOF \geq 0.60 Wet Exterior Wet (EW)

V2 Slight Variation



24"x48"
610010004669 Brave Pearl



24"x24"
600010001909 Brave Pearl



FLOOR
Brave Pearl
24"x48"

INDEX



PRODUCT FINDER >

PRODUCTS >

CONCRETE LOOK

Mark Chrome

MARBLE LOOK

Beyond Dolomite Warm White New

STONE LOOK

Block Bianco

Bluestone Select

Boost Stone Cream New

Boost Stone White New

Brave Gray

Brave Gypsum

Brave Pearl

Fior Di Bosco Gray New

Flagstone Select New

Hero Silver New

Hero Snow New

Seastone Gray

Trust Gold

Trust Silver

WOOD LOOK

Axi White Pine

Axi Brown Chestnut

Axi Gray Timber

PRO RESOURCES >

TECHNICAL SPECIFICATIONS >

Fior di Bosco Gray

Outdoor Sensitech \pm 20 mm



DCOF \geq 0.60 Wet Exterior Wet (EW)



V2 Slight Variation



MADE IN USA

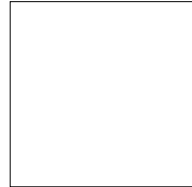

24"x24"
610010005661 Fior di Bosco Gray



FLOOR
Fior di Bosco Gray
24"x24"

PRODUCT FINDER >

PRODUCTS >

CONCRETE LOOK

Mark Chrome

MARBLE LOOK

Beyond Dolomite Warm White New

STONE LOOK

Block Bianco

Bluestone Select

Boost Stone Cream New

Boost Stone White New

Brave Gray

Brave Gypsum

Brave Pearl

Fior Di Bosco Gray New

Flagstone Select New

Hero Silver New

Hero Snow New

Seastone Gray

Trust Gold

Trust Silver

WOOD LOOK

Axi White Pine

Axi Brown Chestnut

Axi Gray Timber

PRO RESOURCES >

TECHNICAL SPECIFICATIONS >

Flagstone Select

Outdoor Sensitech \pm 20 mm



DCOF \geq 0.60 Wet Exterior Wet (EW)



V2 Slight Variation



MADE IN USA

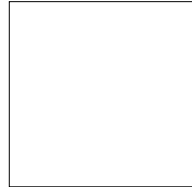

24"x24"
610010005527 Flagstone Select



FLOOR
Flagstone Select
24"x24"

PRODUCT FINDER >

PRODUCTS >

CONCRETE LOOK

Mark Chrome

MARBLE LOOK

Beyond Dolomite Warm White New

STONE LOOK

Block Bianco

Bluestone Select

Boost Stone Cream New

Boost Stone White New

Brave Gray

Brave Gypsum

Brave Pearl

Fior Di Bosco Gray New

Flagstone Select New

Hero Silver New

Hero Snow New

Seastone Gray

Trust Gold

Trust Silver

WOOD LOOK

Axi White Pine

Axi Brown Chestnut

Axi Gray Timber

PRO RESOURCES >

TECHNICAL SPECIFICATIONS >

Hero Silver

Outdoor Sensitech \pm 20 mm



DCOF \geq 0.60 Wet Exterior Wet (EW)



V2 Slight Variation



MADE IN USA

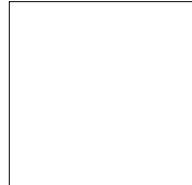

24"x24"
610010005570 Hero Silver

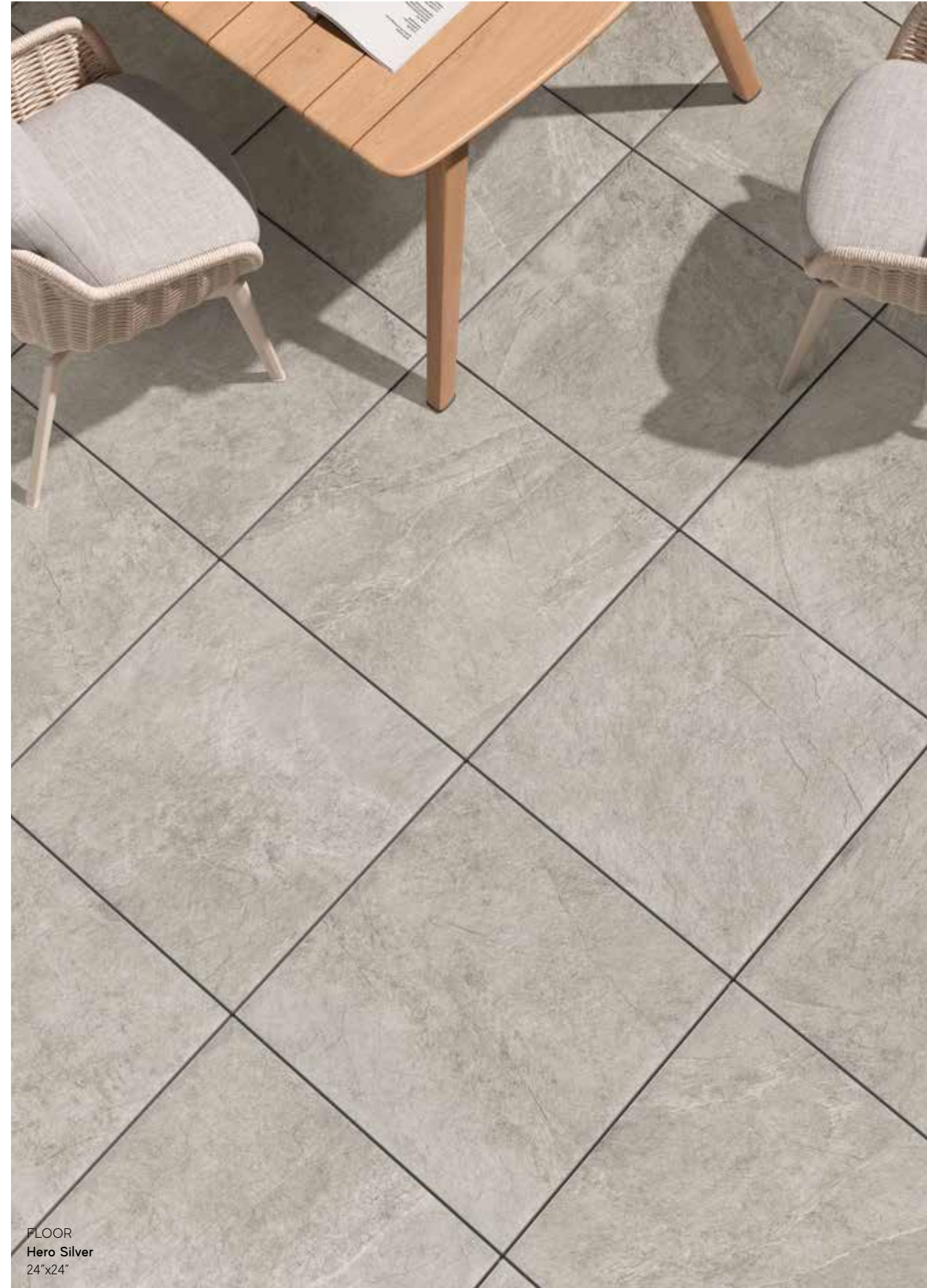

FLOOR
Hero Silver
24"x24"

PRODUCT FINDER >

PRODUCTS >

CONCRETE LOOK
Mark Chrome

MARBLE LOOK
Beyond Dolomite Warm White New

STONE LOOK
Block Bianco
Bluestone Select
Boost Stone Cream New
Boost Stone White New
Brave Gray
Brave Gypsum
Brave Pearl
Fior Di Bosco Gray New
Flagstone Select New

Hero Silver New

Hero Snow New
Seastone Gray
Trust Gold
Trust Silver

WOOD LOOK
Axi White Pine
Axi Brown Chestnut
Axi Gray Timber

PRO RESOURCES >

TECHNICAL SPECIFICATIONS >

Hero Snow

Outdoor Sensitech \approx 20 mm



DCOF \geq 0.60 Wet Exterior Wet (EW)



V2 Slight Variation



MADE IN USA

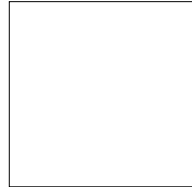

24"x24"
610010005525 Hero Snow



FLOOR
Hero Snow
24"x24"

PRODUCT FINDER >

PRODUCTS >

CONCRETE LOOK
Mark Chrome

MARBLE LOOK
Beyond Dolomite Warm White New

STONE LOOK
Block Bianco
Bluestone Select
Boost Stone Cream New
Boost Stone White New
Brave Gray
Brave Gypsum
Brave Pearl
Fior Di Bosco Gray New
Flagstone Select New
Hero Silver New

Hero Snow New

Seastone Gray
Trust Gold
Trust Silver

WOOD LOOK
Axi White Pine
Axi Brown Chestnut
Axi Gray Timber

PRO RESOURCES >

TECHNICAL SPECIFICATIONS >

Seastone Gray

Outdoor Sensitech \approx 20 mm



DCOF \geq 0.60 Wet Exterior Wet (EW)



V2 Slight Variation



MADE IN USA

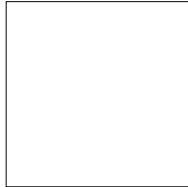

24"x24"
600010001908 Seastone Gray

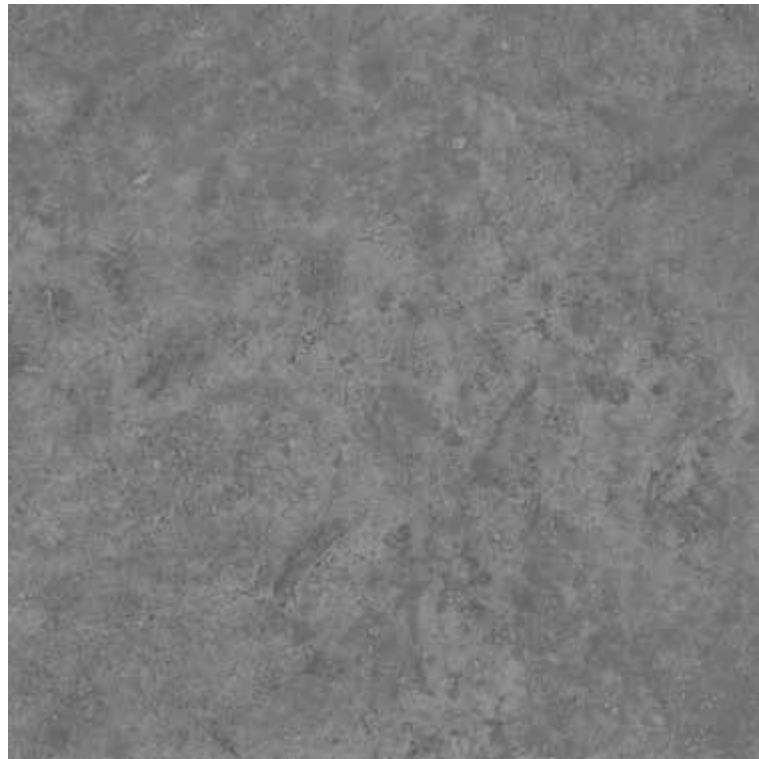

FLOOR
Seastone Gray
24"x24"

PRODUCT FINDER >

PRODUCTS >

CONCRETE LOOK

Mark Chrome

MARBLE LOOK

Beyond Dolomite Warm White New

STONE LOOK

Block Bianco

Bluestone Select

Boost Stone Cream New

Boost Stone White New

Brave Gray

Brave Gypsum

Brave Pearl

Fior Di Bosco Gray New

Flagstone Select New

Hero Silver New

Hero Snow New

Seastone Gray

Trust Gold

Trust Silver

WOOD LOOK

Axi White Pine

Axi Brown Chestnut

Axi Gray Timber

PRO RESOURCES >

TECHNICAL SPECIFICATIONS >

Trust Gold

Outdoor Sensitech \pm 20 mm

DCOF \geq 0.60 Wet Exterior Wet (EW)

V2 Slight Variation

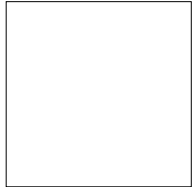

24"x24"
600010001905 Trust Gold



FLOOR
Trust Gold
24"x24"

PRODUCT FINDER >

PRODUCTS >

CONCRETE LOOK

Mark Chrome

MARBLE LOOK

Beyond Dolomite Warm White New

STONE LOOK

Block Bianco

Bluestone Select

Boost Stone Cream New

Boost Stone White New

Brave Gray

Brave Gypsum

Brave Pearl

Fior Di Bosco Gray New

Flagstone Select New

Hero Silver New

Hero Snow New

Seastone Gray

Trust Gold

Trust Silver

WOOD LOOK

Axi White Pine

Axi Brown Chestnut

Axi Gray Timber

PRO RESOURCES >

TECHNICAL SPECIFICATIONS >

Trust Silver

Outdoor Sensitech \approx 20 mm



DCOF \geq 0.60 Wet Exterior Wet (EW)



V2 Slight Variation



MADE IN USA

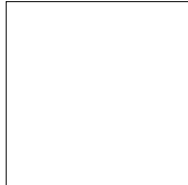

24"x24"
600010001906 Trust Silver



FLOOR
Trust Silver
24"x24"

PRODUCT FINDER >

PRODUCTS >

CONCRETE LOOK

Mark Chrome

MARBLE LOOK

Beyond Dolomite Warm White New

STONE LOOK

Block Bianco

Bluestone Select

Boost Stone Cream New

Boost Stone White New

Brave Gray

Brave Gypsum

Brave Pearl

Fior Di Bosco Gray New

Flagstone Select New

Hero Silver New

Hero Snow New

Seastone Gray

Trust Gold

Trust Silver

WOOD LOOK

Axi White Pine

Axi Brown Chestnut

Axi Gray Timber

PRO RESOURCES >

TECHNICAL SPECIFICATIONS >

Axi Brown Chestnut

Outdoor Sensitech \pm 20 mm

DCOF \geq 0.60 Wet
Exterior Wet (EW)

V2
Slight Variation

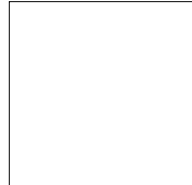

24"x24"
610010002311 Axi Brown Chestnut



FLOOR
Axi Brown Chestnut
24' x24'

PRODUCT FINDER >

PRODUCTS >

CONCRETE LOOK

Mark Chrome

MARBLE LOOK

Beyond Dolomite Warm White New

STONE LOOK

Block Bianco

Bluestone Select

Boost Stone Cream New

Boost Stone White New

Brave Gray

Brave Gypsum

Brave Pearl

Fior Di Bosco Gray New

Flagstone Select New

Hero Silver New

Hero Snow New

Seastone Gray

Trust Gold

Trust Silver

WOOD LOOK

Axi White Pine

Axi Brown Chestnut

Axi Gray Timber

PRO RESOURCES >

TECHNICAL SPECIFICATIONS >

Axi Gray Timber

Outdoor Sensitech \pm 20 mm



DCOF \geq 0.60 Wet
Exterior Wet (EW)



V2
Slight Variation



MADE IN USA

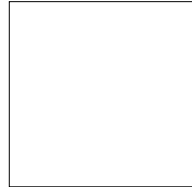

24"x24"
610010002310 Axi Gray Timber

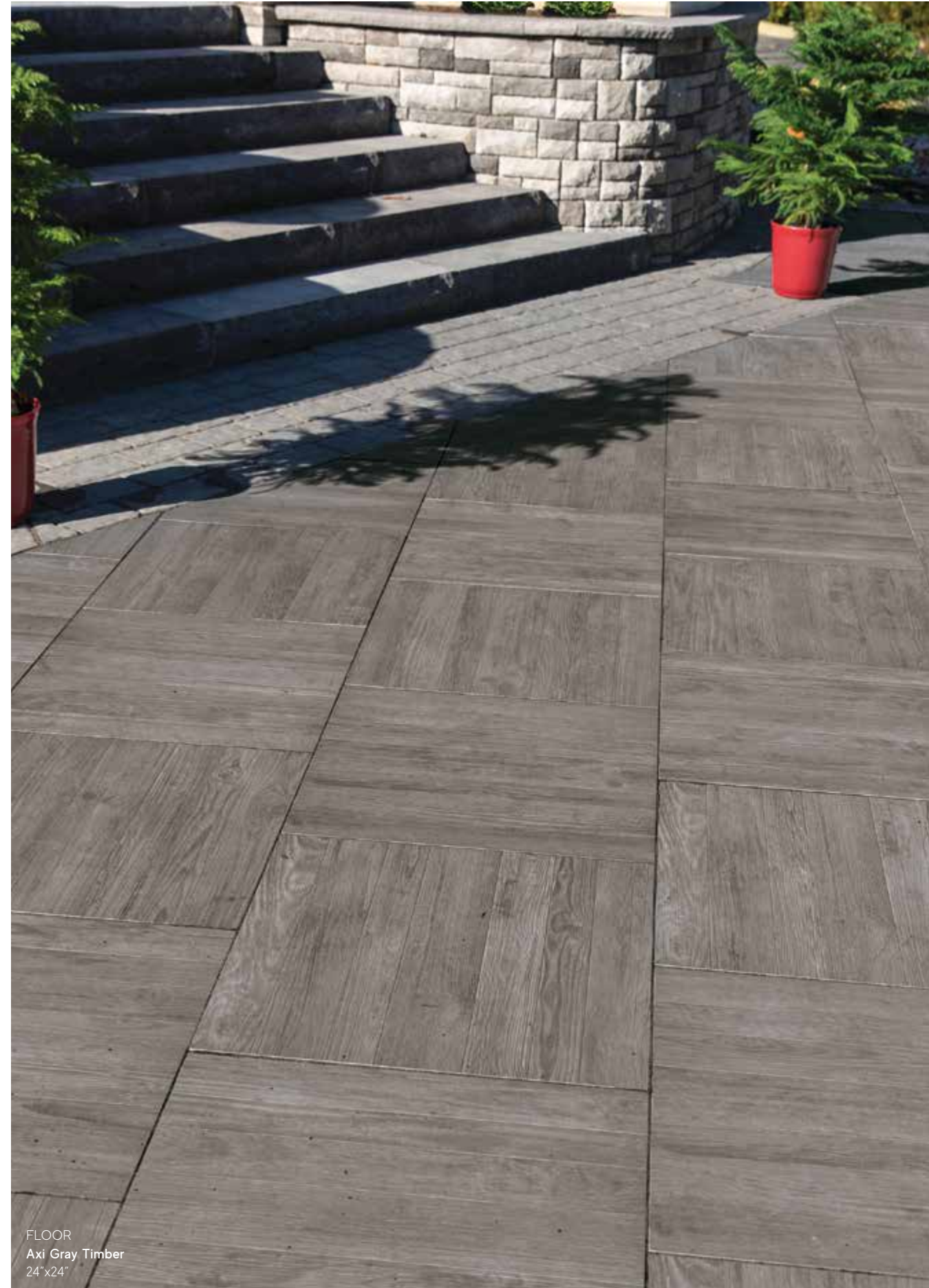

FLOOR
Axi Gray Timber
24"x24"

PRODUCT FINDER >

PRODUCTS >

CONCRETE LOOK

Mark Chrome

MARBLE LOOK

Beyond Dolomite Warm White New

STONE LOOK

Block Bianco

Bluestone Select

Boost Stone Cream New

Boost Stone White New

Brave Gray

Brave Gypsum

Brave Pearl

Fior Di Bosco Gray New

Flagstone Select New

Hero Silver New

Hero Snow New

Seastone Gray

Trust Gold

Trust Silver

WOOD LOOK

Axi White Pine

Axi Brown Chestnut

Axi Gray Timber

PRO RESOURCES >

TECHNICAL SPECIFICATIONS >

Axi White Pine

Outdoor Sensitech \pm 20 mm

DCOF \geq 0.60 Wet Exterior Wet (EW)

V2 Slight Variation

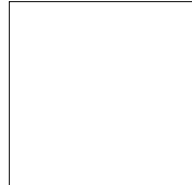

24"x24"
610010002312 Axi White Pine



FLOOR
Axi White Pine
24" x24"

PRODUCT FINDER >

PRODUCTS >

CONCRETE LOOK

Mark Chrome

MARBLE LOOK

Beyond Dolomite Warm White New

STONE LOOK

Block Bianco

Bluestone Select

Boost Stone Cream New

Boost Stone White New

Brave Gray

Brave Gypsum

Brave Pearl

Fior Di Bosco Gray New

Flagstone Select New

Hero Silver New

Hero Snow New

Seastone Gray

Trust Gold

Trust Silver

WOOD LOOK

Axi White Pine

Axi Brown Chestnut

Axi Gray Timber

PRO RESOURCES >

TECHNICAL SPECIFICATIONS >



PRODUCT FINDER >

Pro Resources

Information & Inspiration 52
Merchandising 54

PRODUCTS >

PRO RESOURCES >

Information & Inspiration
Merchandising

TECHNICAL SPECIFICATIONS >

PRO NETWORK

Information & Inspiration

The Atlas Concorde USA Professional Network, your gateway to webinars, in store learning materials and more.



PRODUCT FINDER >

Webinars



Top 10 Tile Questions Answered
Here is the 2020 countdown list you want to hear! Each day we receive emails and calls from across the country on different tile-specific question: "How do you choose the best product for outdoor applications?" "How significant can the difference in dye lots be?" and many more. Can you relate?
— [Watch the Webinar Now](#)



New Atlas Concorde Fall 2020 Collections
Are you ready for a boost? Atlas Concorde has three new Fall collections that you have to see! Join Atlas Concorde USA in a live webinar to see these new looks, learn about the design process, and unique selling points.
— [Watch the Webinar Now](#)



Keeping it Clean: How Tile Helps Create Clean Environments
Join us and Fila Solutions as we discuss the hygienic benefits of tile, how tile helps create clean environments and much more.
— [Watch the Webinar Now](#)

Learn about trends, new products, and customer insight in our live and recorded webinars.

PRODUCTS >

Launch Presentations



2020 Collection Launch
Learn about the five new collections launched in 2020. In the presentation, you'll see the full range and gain insight into the research and inspiration for each product.
— [Fresh Insight Here](#)



Atlas Concorde - Boost Pro
Learn about Boost Pro, one of the new spring collections launched for Atlas Concorde. In the presentation, you'll see the full range and gain insight into the research and inspiration for each product.
— [Learn About Boost Pro](#)



Atlas Concorde - Lims
Learn about Lims, one of the new spring collections launched for Atlas Concorde. In the presentation, you'll see the full range and gain insight into the research and inspiration for each product.
— [Learn About Lims](#)

Find fresh insights and details on our newest product releases.



IN STORE Training
The Atlas Concorde USA In-Store Training Program is designed to help dealers understand the basics, product specifics, and sales techniques.
— [Learn More Today and Tomorrow](#)



IN STORE Design
Atlas Concorde USA stands out from the competition. Fresh displays will help you demonstrate this in your showroom.
— [Update Your In-Store Look Today](#)

The Atlas Concorde USA In Store training program is designed to help dealers understand tile basics, product specifics, and sales techniques. Show your customers the beauty and versatility of Atlas Concorde USA in the best way. Our showroom displays, resources and samples are here to help you create and close the sale.

Product Training Videos



Impression Training Video
Explore this Mediterranean up-to-date look that allows great versatility for many interior design styles.
— [Inspect Impression](#)



Exist Training Video
Learn more about this historical look, which conveys natural elements influenced by urban details.
— [Examine Exist](#)



Reflex Training Video
See how the shimmering look of metal with the solid mood of concrete, add an urban feeling to environments.
— [Realize Reflex](#)

Looking to increase your sales? Improve your product knowledge and Atlas Concorde USA awareness with these short, informative videos.

Need more samples for your showroom?



AtlasConcordeUSA samples now available on Material Bank materialbank.com

PRO RESOURCES >

Information & Inspiration

Merchandising

TECHNICAL SPECIFICATIONS >

Merchandising

See our full catalog of merchandising and displays









Displays

Depth x Width x Height



20" x 22" x 19.75"

Code (SAP code) **Description**
 550030000511 **OUTDOOR PAVER DISPLAY**
 Innovative, light-weight display that shows one full size paver and 15 chips.

-  Innovative Lightweight Material
-  High visibility of each piece
-  Weatherproof
-  Holds 1 full-size paver (24" x 24")
-  Small footprint
-  15 paver chips (8" x 8")
-  Ready to go, no assembly needed

For packaging information, see page 68

Paver Chip Kit









Code **Description**
 540040006662 **PAVER CHIP KIT 2024**

The kit includes 7 different chips. All chips are 8"x8" and 20mm.

All chips have a label on the back with the product name.

Code **Available products**

610010005571	BOOST STONE WHITE 24"X24"				
610010005525	HERO SNOW 24"X24"				
610010005526	BOOST STONE CREAM 24"X24"				
610010005527	FLAGSTONE SELECT 24"X24"				
610010005570	HERO SILVER 24"X24"				
610010005661	FIOR DI BOSCO GRAY 24"X24"				
610010005660	BEYOND DOL. WARM WHITE 24"X24"				

Code **Available products**

The kit includes 12 different chips. All chips are 8"x8" and 20mm.

All chips have a label on the back with the product name.

Code **Available products**

610010004761	BLUESTONE 24"X24"				
610010004672	BLUESTONE 24"X48"				
600010009002	MARK CHROME 24"X24"				
610010004671	MARK CHROME 24"X48"				
600010001909	BRAVE PEARL 24"X24"				
610010004669	BRAVE PEARL 24"X48"				
600010001910	BRAVE GRAY 24"X24"				
600010001911	BRAVE GYPSUM 24"X24"				
610010002312	AXI WHITE PINE 24"X24"				
610010002311	AXI BROWN CHESTNUT 24"X24"				
610010002310	AXI GRAY TIMBER 24"X24"				
600010001912	BLOCK BIANCO 24"X24"				
600010001908	SEASTONE GRAY 24"X24"				
600010001905	TRUST GOLD 24"X24"				
600010001906	TRUST SILVER 24"X24"				

For packaging information, see page 68

PRODUCT FINDER >

PRODUCTS >

PRO RESOURCES >

Information & Inspiration
 Merchandising

TECHNICAL SPECIFICATIONS >



PRODUCT FINDER >

PRODUCTS >

PRO RESOURCES >

TECHNICAL SPECIFICATIONS >

- Installation Methods
- Technical Information
- Trims Tiles
- Environmental Sustainability
- Certifications
- Technical Specifications
- Color Shading
- Tile Packaging
- Merchandising Packaging
- General Sales Conditions

Technical Specifications

Installation Methods	58
Technical Information	60
Trims Tiles	62
Environmental Sustainability	64
Certifications	65
Technical Specifications	66
Color Shading	67
Tile Packaging	68
Merchandising Packaging	68
General Sales Conditions	69

DRY INSTALLATION

ONTO GRASS

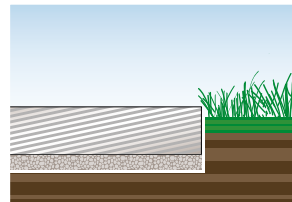

For proper installation of **LASTRA 20mm** on grass or soil for walkways, it is always recommended for the walking surface to be at the same level as the turf. Please follow the instructions below:

1. Preparation of the substrate

Dig out 2" of soil and lay a layer of geotextile. Then fill with a bed of paver sand.

2. Positioning:

Position the pieces according to the pattern chosen, carefully using a rubber hammer on the surfaces to properly set them in place on the support medium.

3. Joints:

It is recommended to lay the pieces with at least 1" of space between them.

ONTO SAND

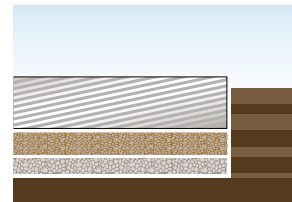

For proper installation of **LASTRA 20mm** on sand, please follow the instructions below:

1. Preparing the substrate

Dig the soil to a depth of 6"-8" based on the ground's drainage capability. Compact the bottom, applying a minimum slope of 2%. Install a layer of geotextile so that the drainage is well dispersed and roots don't become a problem.

2. Drainage layer

Prepare a drainage layer with 3/4" road base. Level and compact, maintaining the bottom's slope. Lay geotextile on top of the layer of stone chips to keep it from mixing with the substrate.

3. Lateral containment

Install lateral containment suitable for the depth of the substrate and the thickness of the tiles.

4. Setting bed

Make a 1" setting bed with a layer of paver sand. Level the substrate, maintaining a minimum slope of 2%.

5. Installation

Lay the pavers according to the desired pattern, leaving a minimum joint of 3/16" using the appropriate spacers. To improve the stability of the pavers on the substrate, carefully hammer the surface with a rubber hammer.

6. Joints

The joints can be left empty, filled with washed non-clay sand or with grout made of draining polymer sand.

TRADITIONAL INSTALLATION

WITH ADHESIVE

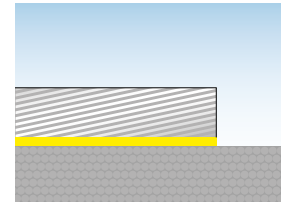

For the correct adhesive installation of **LASTRA 20mm**, it is recommended to follow the instructions below:

1. Preparation of the substrate

Prepare a layer of 10cm made up gravel and pebbles with 16-35mm granulometry. Carry out a concrete layer with minimum thickness of 15-20cm and minimum inclination of 2%.

2. Setting bed

Spread a reinforcement screed of at least 5cm with electro-welded net at 2/3 of the thickness if necessary;

3. Installation of slabs

Install the slabs with the double spreading method and using deformable cement-based premium adhesives (class C2S2 in compliance with EN 12004);

4. Joints

It is recommended to place the slabs leaving a joint of at least 5mm between each other using cement-based premium mortars (in compliance with TCA F101 and F102);

5. Expansion joints

Every 9-16 m² and depending on the size and shape of the floor, introduce expansion joints of 5mm minimum width.

It is possible to lay LASTRA 20mm on draining mixtures composed of gravel and cement, being sure to follow the cement manufacturer's instructions and the project specifications. Outdoor flooring made with LASTRA 20mm on gravel and cement mixtures can be used for walking on.

RAISED INSTALLATION

ON PEDESTALS

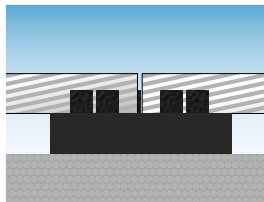

For proper installation of **LASTRA 20mm** on raised floors, in the case of even and compact surfaces follow the instructions below:

1. Base and substrate preparation

Prepare a screed with a slope of 2%, followed by a layer of waterproofing. Spread a membrane for draining off the rainwater making sure that it is suitable to withstand the loads and stresses it will be subjected to.

2. Joints

The joint between the pavers, defined by the thickness of the spacers on top of the support, is equal to about 4 mm. For the raised installation of 23^{5/8}"x23^{5/8}" - 60x60 slabs in 3/4" - 20mm thickness, a maximum raise of the foot plan of 3/4" - 2 cm is recommended.

SIZE	UP TO 3/4" (2CM)	ABOVE 3/4" (2CM)
24"x24" 60x60cm (Nominal) 4 supports per slab	4 SUPPORTS (0,32 pcs/sq ft)	Contact Atlas Concorde USA

WARNING

- OUTDOOR PAVINGS INSTALLED UNGLUED ABOVE THE GROUND LEVEL ARE SUBJECT TO THE ACTION OF THE WIND, WITH THE RISK, IN SOME CASES, OF BECOMING AIRBORNE. THE MANUFACTURER RECOMMENDS TO REQUIRE THE ASSISTANCE OF A QUALIFIED PROFESSIONAL IN ORDER TO CHECK THE SUITABILITY OF THE INSTALLATION SYSTEM ABOVE THE GROUND ADOPTED, IN ACCORDANCE WITH THE LOCAL LAWS AND REGULATIONS AND THE CONDITIONS OF USE. FAILURE TO DO SO COULD RESULT IN SERIOUS INJURY OR PROPERTY DAMAGE. A CERAMIC SLAB INSTALLED ON A RAISED PEDESTAL SYSTEM MAY FRACTURE ON IMPACT IF A HEAVY OBJECT IS DROPPED ONTO IT FROM A HEIGHT, WITH A RISK OF INJURY TO ANYONE STANDING OR WALKING ON SUCH SLAB. FAILURE TO ADHERE TO THE MANUFACTURER'S INSTRUCTIONS FOR INSTALLATION OF SLABS ON RAISED PEDESTAL SYSTEMS MAY RESULT IN SERIOUS INJURY. FOR FURTHER INFORMATION AND RECOMMENDATIONS CONCERNING THE INSTALLATION SYSTEMS PLEASE REFER TO THE LASTRA 20MM SECTION ON THE ATLAS CONCORDE WEBSITE OR TO THE LASTRA 20MM CATALOGUE.

PRODUCT FINDER >

PRODUCTS >

PRO RESOURCES >

TECHNICAL SPECIFICATIONS >

- Installation Methods
- Technical Information
- Trims Tiles
- Environmental Sustainability
- Certifications
- Technical Specifications
- Color Shading
- Tile Packaging
- Merchandising Packaging
- General Sales Conditions

Technical Information

Cutting

To cut LASTRA 20mm pavers, it is recommended to use a wet saw with at least 1.5 HP power with 8"-10" diamond blade.



Grout lines

In case of dry installation onto gravel, Atlas Concorde recommends leaving a grout line of at least 3/16" between adjacent tiles, using spacers. It is recommended to use spacers in order to maintain a correct joint over time. Grout lines can be also filled with colored polymeric sand matching the tile. Please follow manufacturer's instructions.



Cleaning and maintenance

Cleaning and maintenance procedures can be carried out using a common neutral detergent and a pressure washer: the draining power of inclined surfaces and the presence of open joints between slabs encourages the collection of dirt near the discharge points. For large surfaces, the use of a washer-dryer and single-brush machines with soft nylon brushes is recommended.



Please note that a water patina, due to the surface tension feature of liquids, will tend to form on any outdoor surface even when inclined properly. To remove this patina and obtain the complete drying of the floor, push the water towards joints using a scrubbing-brush or to use a wet and dry vacuum cleaner.



PRODUCT FINDER >

PRODUCTS >

PRO RESOURCES >

TECHNICAL SPECIFICATIONS >

- Installation Methods
- Technical Information
- Trims Tiles
- Environmental Sustainability
- Certifications
- Technical Specifications
- Color Shading
- Tile Packaging
- Merchandising Packaging
- General Sales Conditions

Trim Tiles

ROUND
12"x24" - 30x60 cm
Working Size
598x297 mm

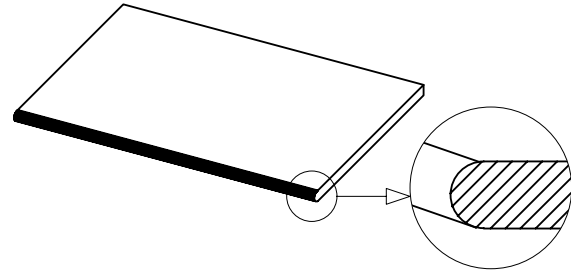

ROUND ANGLE LEFT/RIGHT
12"x24" - 30x60 cm
Working Size
598x297 mm

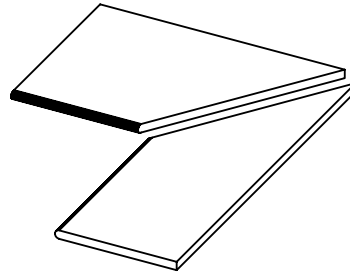

GRADINO ROUND
12"x24" - 30x60 cm
Working Size
598x297 mm

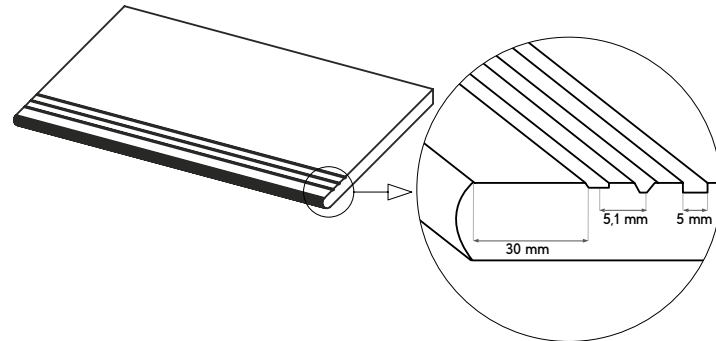

GRADINO ROUND ANGLE LEFT/RIGHT
12"x24" - 30x60 cm
Working Size
598x297 mm

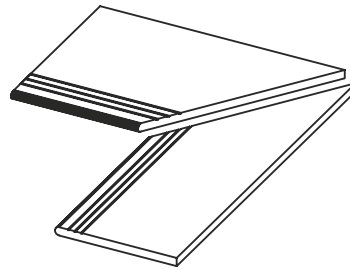

Tailored solutions for every project

Explore the perfect balance of convenience and customization with our Cut-to-Order Program. Elevate your space with tailored tiles that meet your unique vision.

Classic Cuts

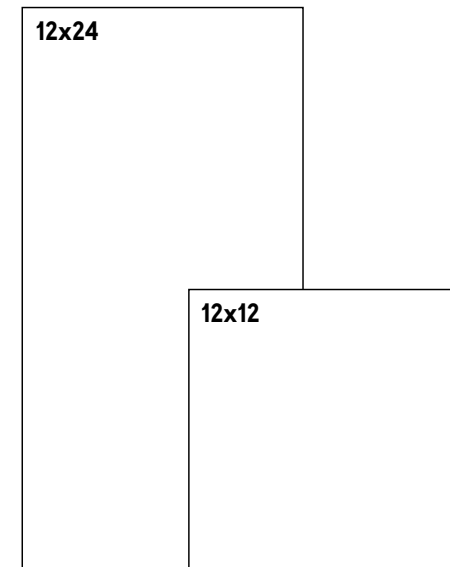

Choose from our curated selection of standard sizes, ensuring a seamless ordering experience.

Terms and Conditions of Sale

Minimum order quantities must be respected. When the production is completed, customers must pick up the whole batch for each non-standard product ordered. shipment splitting is not accepted, and Atlas Concorde USA does not keep stock of any non-standard product in any quantity.

If production volumes exceed quantities of the material ordered by up to 5%, customers have to pick up the total quantity. Refer to your Sales Representative and Customer Service to confirm the actual ETA. Atlas Concorde USA is not responsible for any availability delay

concerning non-standard products. Atlas Concorde USA will not accept any non-standard product returns. For any other aspect, please refer to the Atlas Concorde USA General Terms and Conditions of Sale.

PRODUCT FINDER >

PRODUCTS >

PRO RESOURCES >

TECHNICAL SPECIFICATIONS >

Installation Methods
Technical Information

Trims Tiles

Environmental Sustainability
Certifications

Technical Specifications

Color Shading

Tile Packaging

Merchandising Packaging

General Sales Conditions

Environmental Sustainability

Environment and health



Advanced purification systems, which contribute to the containment of atmospheric emissions



100% recyclable packaging materials

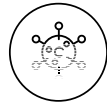

0% lead, cadmium, and other dangerous substances in products



All Atlas Concorde products, during their use, do not release VOCs (Volatile Organic Compounds)

Waste management



100% of cooked and raw waste recovered internally



100% water recovered for internal use

Certifications

Company certifications



Product certifications



Product declarations



Certification for buildings



Atlas Concorde porcelain tiles and single-fired products can contribute towards earning points needed for LEED® certification.

Industry associations



PRODUCT FINDER >

PRODUCTS >

PRO RESOURCES >

TECHNICAL SPECIFICATIONS >

Installation Methods
Technical Information
Trims Tiles

Environmental Sustainability
Certifications

Technical Specifications
Color Shading
Tile Packaging
Merchandising Packaging
General Sales Conditions

Technical Specifications

Outdoor pavers

	Property	Test Method	Requirements	
			Calibrated	
Regularity characteristics	Nominal Size	ASTM C499	-3.00% ÷ +2.00%	Compliant
	Caliber Range		±0.25% or ±0.03 in (±0.8 mm) (*)	Compliant
	Thickness ⁽¹⁾		Range: 0.40 in (1.02 mm)	Compliant
	Wedging	ASTM C502	±0.25% or ±0.03 in (±0.8 mm) (*)	Compliant
	Warpage Edge	ASTM C485	±0.40% or ±0.05 in (±1.3 mm) (*)	Compliant
	Warpage Diagonal		±0.40% or ±0.07 in (±1.8 mm) (*)	Compliant
Structural characteristics	Water Absorption	ASTM C373	≤ 0.5%	≤ 0.5%
Bulk mechanical characteristics	Breaking Strength	ASTM C648	Average ≥ 250 lbf. (1.11 kN) Individual ≥ 225 lbf. (1.00 kN)	≥ 2200 lbf. avg
			Outdoor ∇ 20	Outdoor ∇ 20
	Modulus of Rupture	ASTM C1050	5000 psi.	Compliant
Physical properties	Bond Strength	ASTM C482	≥ 50 psi. (0.34 Mpa)	≥ 100 psi.
Thermal and hygrometric characteristics	Resistance to Freeze/Thaw Cycling	ASTM C1026	As Reported	Resistant
	Thermal Shock Resistance	ASTM C484	As Reported	Resistant
Chemical characteristics	Chemical Resistance	ASTM C650	As Reported	Unaffected
	Stain Resistance	ASTM C1378	As Reported	Unaffected
Safety characteristics	Dynamic Coefficient of Friction (DCOF)	ANSI A326.3	Requires a minimum value of 0.60 for commercial areas that are likely to be wet	> 0.60 Wet Exterior Wet (EW) ⁽²⁾

(*) Whichever is less
 (1) May not apply to textured surfaces or tiles with uneven back patterns.
 (2) For updated manufacturer classification, according to ANSI A326.3 Section 4 - "Product Use Categories", please refer to our website.

Color Shading

The V-Shade classification indicates the chromatic and/or surface variation among tiles of the same collection.



PRODUCT FINDER >

PRODUCTS >

PRO RESOURCES >

TECHNICAL SPECIFICATIONS >

- Installation Methods
- Technical Information
- Trims Tiles
- Environmental Sustainability
- Certifications

Technical Specifications
 Color Shading

- Tile Packaging
- Merchandising Packaging
- General Sales Conditions



Tile Packaging

Description	Size (inches)	Thickness (mm)	Pieces per box	Sq.Ft. per box	Box per pallet	Sq.Ft. per pallet	Lbs. per box	Lbs. Per pallet
24"x24"	23 ⁵ / ₈ " x 23 ⁵ / ₈ "	20	2	7.75	30.00	232.50	72.76	2,182.80
24"x48"	23 ⁵ / ₈ " x 47 ¹ / ₄ "	20	1	7.75	32.00	248.00	74.01	2,368.32

Merchandising Packaging

ITEM	Description	Display Unit				Packaging			
		A	B	C	Weight	A	B	C	Weight
550030000511	Outdoor Paver Display	50"	23"	16"	17.6 lbs	52"	24.8"	16.9"	18.7 lbs
540040006636	Paver Chip Kit 2023					13"	16 1/2"	8 1/2"	22.5 lbs
540040006662	Paver Chip Kit 2024					13"	16 1/2"	8 1/2"	22.5 lbs

DISPLAY UNIT

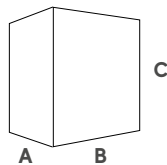

PACKAGING

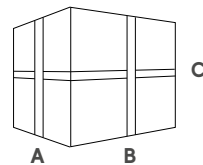

General Sales Conditions

Terms and Conditions of Sale Atlas Concorde USA, Inc.

In these Terms and Conditions of Sale, Atlas Concorde USA, Inc., is referred to as "Atlas Concorde USA" and the customer or person or entity purchasing Atlas Concorde USA's products (the "Goods") from Atlas Concorde USA is referred to as the "Buyer". For purposes of these Terms and Conditions of Sale, order confirmation and pro-forma invoice shall be interchangeable.

These Terms and Conditions of Sale, and Atlas Concorde USA's order confirmation (usually in the form of a pro-forma invoice) constitute the complete and exclusive agreement and understanding governing the sale of Goods by Atlas Concorde USA to Buyer (the "Agreement") and supersede all prior agreements, understandings or representations, whether written or oral, among the parties with respect to such matters. Provided, however, that if any term, provision or condition of Atlas Concorde USA's order confirmation should conflict or be inconsistent with any term of these Terms and Conditions, then the terms of Atlas Concorde USA's order confirmation shall prevail and control over such conflicting and/or inconsistent terms.

BY ACCEPTING ATLAS CONCORDE USA'S ORDER CONFIRMATION - PRO FORMA INVOICE AND/OR INSTRUCTING ATLAS CONCORDE USA TO SHIP GOODS (EITHER BY FACSIMILE OR E-MAIL COMMUNICATION), BUYER WILL MANIFEST ITS ACKNOWLEDGMENT, ACCEPTANCE AND AGREEMENT TO THESE TERMS AND CONDITIONS.

Atlas Concorde USA reserves the right to refuse any order, in its sole discretion. No order is accepted by Atlas Concorde USA until: (i) Atlas Concorde USA provides Buyer with a written order confirmation, and (ii) Buyer duly signs the order confirmation in acknowledgement, acceptance and agreement, and returns the signed order confirmation to Atlas Concorde USA.

1. PRICES

All prices for Goods, including, but not limited to, those specified in Atlas Concorde USA's price list or schedule, website or written quotation, are subject to change without notice. Such prices shall be automatically adjusted to reflect Atlas Concorde USA's prices for Goods as in effect at the time of the requested shipment date, and each shipment will be invoiced at such adjusted prices. Unless otherwise expressly agreed by Atlas Concorde USA in writing, all prices are EX WORKS (which shall have the same meaning as in the Incoterms 2000 published by the International Chamber of Commerce), exclusive of any applicable taxes, duties, sales taxes, transportation and insurance costs or charges (collectively "Charges"), which Charges are to be borne exclusively by Buyer.

2. TERMS OF PAYMENT

Unless otherwise expressly agreed by Atlas Concorde USA in writing in Atlas Concorde USA's order confirmation, the purchase price for all orders shall be paid in full in advance of shipment.

All payments must be made in U.S. currency. In the event Buyer fails to make any payment when due, Atlas Concorde USA shall have the right, in addition to all other remedies available to Atlas Concorde USA either at law or in equity, to either terminate this Agreement immediately, without notice, or to suspend further performance under this Agreement. Buyer shall be liable for all expenses, including reasonable attorneys' fees, relating to the collection of past due amounts. If any payment owed to Atlas Concorde USA is not paid when due, it shall accrue interest at the rate of the lesser of 15% per annum, or the maximum amount permitted by applicable law, from the date on which such past due amount is due until the past due amount is paid in full. Should Buyer's financial responsibility become unsatisfactory to Atlas Concorde USA, cash payments or security satisfactory to Atlas Concorde USA may be required by Atlas Concorde USA for future deliveries and for the Goods theretofore delivered. If such cash payment or security is not provided, in addition to Atlas Concorde USA's other rights and remedies, Atlas Concorde USA may discontinue deliveries.

3. SHIPMENT AND DELIVERY

Unless otherwise expressly agreed in writing by Atlas Concorde USA, shipments are made EX WORKS (which shall have the same meaning as in the Incoterms 2000 published by the International Chamber of Commerce). Risk of loss or damage and responsibility shall pass from Atlas Concorde USA to Buyer upon delivery of the Goods to carrier. Any claims for shortages or damages suffered in transit are the responsibility of Buyer and shall be submitted by Buyer directly to the carrier. Shortages or damages must be acknowledged and signed for at the time of delivery. While Atlas Concorde USA will use all reasonable commercial efforts to maintain the delivery date(s) acknowledged or quoted by Atlas Concorde USA, all shipping dates are approximate and not guaranteed. Atlas Concorde USA reserves the right to make partial shipments. Atlas Concorde USA, at its option, shall not be bound to tender delivery of any Goods for which Buyer has not provided accurate shipping instructions. If the shipment of the Goods is postponed or delayed by Buyer for any reason, including but not limited to, Buyer providing Atlas Concorde USA with inaccurate shipping instructions, then Buyer agrees to reimburse Atlas Concorde USA for any and all transport and/or storage costs and other additional and incidental expenses resulting therefrom.

4. LIMITED WARRANTY

Subject to the limitations set forth in Section 5 below, Atlas Concorde USA warrants that Goods sold by Atlas Concorde USA as "first choice goods" are manufactured in accordance with the published technical standards. This limited warranty is valid only: (i) for a period of one hundred and eighty (180) days from the date of shipment of the Goods by Atlas Concorde USA, or (ii) for the period from the date of shipment of the Goods by Atlas Concorde USA until installation or attempted installation of the Goods, whichever is less. This

limited warranty applies only to "first choice goods" sold by Atlas Concorde USA.

ALL GOODS SOLD BY ATLAS CONCORDE USA OTHER THAN "FIRST CHOICE GOODS" ARE SOLD AS IS. THIS IS THE SOLE AND EXCLUSIVE WARRANTY GIVEN BY ATLAS CONCORDE USA WITH RESPECT TO THE GOODS AND IS IN LIEU OF AND EXCLUDES ALL OTHER WARRANTIES, EXPRESS OR IMPLIED, ARISING BY OPERATION OF LAW OR OTHERWISE, INCLUDING WITHOUT LIMITATION, MERCHANTABILITY AND FITNESS FOR A PARTICULAR PURPOSE WHETHER OR NOT THE PURPOSE OR USE HAS BEEN DISCLOSED TO ATLAS CONCORDE USA, AND WHETHER OR NOT ATLAS CONCORDE USA'S 'S PRODUCTS ARE SPECIFICALLY DESIGNED AND/OR MANUFACTURED BY ATLAS CONCORDE USA AND/ FOR BUYER'S (OR ANY SUBSEQUENT TRANSFEREE'S, AS DEFINED BELOW) USE OR PURPOSE.

OTHER THAN REPRESENTATIONS OR WARRANTIES MADE BY ATLAS CONCORDE USA IN THEIR RESPECTIVE LITERATURE AND/OR PACKAGING, NO REPRESENTATION OR WARRANTY OF ANY KIND REGARDING THE GOODS MADE BY ANY PERSON OR ENTITY INCLUDING, BUT NOT LIMITED TO, INDEPENDENT DISTRIBUTORS AND SALES REPRESENTATIVES, SHALL BE BINDING UPON ATLAS CONCORDE USA .

IF YOU ARE A CONSUMER, AND SHOULD ANY APPLICABLE LAW PROHIBIT THE DISCLAIMER OF IMPLIED WARRANTIES SET FORTH ABOVE, THEN ANY IMPLIED WARRANTIES FOUND TO EXIST WILL BE STRICTLY LIMITED TO THE DURATION OF THE LIMITED WARRANTY SET FORTH ABOVE.

Notwithstanding the foregoing, this limited warranty does not extend to any losses or damages due to misuse, accident, abuse, neglect, normal wear and tear, negligence (other than Atlas Concorde USA's 's), unauthorized modification or alteration, use beyond rate capacity, improper installation, maintenance or application. To the extent that Buyer or its agents have supplied specifications, information, representation of operating conditions or other data to Atlas Concorde USA in the selection or design of the Goods and the preparation of Atlas Concorde USA's quotation, and in the event that actual operating conditions or other conditions differ from those represented by Buyer, any warranties or other provisions contained herein which are affected by such conditions shall be null and void.

Buyers must notify Atlas Concorde USA of any defects in the Goods in writing, via certified mail to Atlas Concorde USA, at 117 Seaboard Lane - Suite F170, Franklin, TN 37067, within thirty (30) days of Buyer's receipt of the Goods. Upon receiving Buyer's notice of defect, Atlas Concorde USA shall, at its option, repair, correct or replace the Goods EX WORKS (which shall have the same meaning as in the Incoterms 2000 published by the International Chamber of Commerce), or refund the purchase price for that portion of the Goods found by Atlas Concorde USA to be defective. Failure by Buyer to give such written notice within the applicable time period shall be deemed an absolute and unconditional waiver of Buyer's claim for such defects. Goods repaired or replaced during the warranty period shall be covered by the foregoing warranty for the remainder of the original warranty period or ninety (90) days from the date of shipment, whichever is longer. Notwithstanding the provisions contained in the preceding sentences of this paragraph, Buyer shall be deemed to have accepted the Goods and absolutely and unconditionally waived its rights to claim for any defects: (i) upon installation or attempted installation of the Goods, or (ii) if the Goods are otherwise used or altered in any way.

Buyer assumes all other responsibility for any loss, damage, or injury to persons or property arising out of, connected with, or resulting from the use of Goods, either alone or in combination with other products/components.

This Section 4 also applies in the event that any entity or person (other than Buyer) buys, acquires or uses the Goods, including, but not limited to, any entity or person who obtains the Goods from Buyer (any of them a "Subsequent Transferee"). Buyer hereby covenants and agrees to provide such Subsequent Transferee with conspicuous written notice of the provisions set forth in Sections 4 and 5 of these Terms and Conditions of Sale, by providing each such Subsequent Transferee with a copy of the notice attached hereto as Exhibit "A". Buyer, furthermore, covenants and agrees that it shall not make any representation or warranty whatsoever regarding the Goods to any third party (either on behalf of Atlas Concorde USA or on its own account), other than the limited warranty of Atlas Concorde USA set forth in this Section 4.

BUYER HEREBY COVENANTS AND AGREES THAT, SHOULD IT FAIL TO COMPLY WITH THE PROVISIONS OF THIS LAST PARAGRAPH OF SECTION 4, BUYER SHALL DEFEND, INDEMNIFY, AND HOLD ATLAS CONCORDE USA AND/, ITS OFFICERS, EMPLOYEES, AND AGENTS HARMLESS FROM AND AGAINST ANY AND ALL LIABILITY, LOSS, EXPENSE (INCLUDING REASONABLE ATTORNEYS' FEES), OR CLAIMS FOR INJURY OR DAMAGES (INCLUDING, BUT NOT LIMITED TO GENERAL, CONSEQUENTIAL, INCIDENTAL AND PUNATIVE DAMAGES) ARISING OUT OF OR IN CONNECTION WITH BUYER'S OR BUYER'S EMPLOYEES', AGENTS', REPRESENTATIVES' AND/OR INDEPENDENT CONTRACTORS' BREACH OF THESE TERMS AND CONDITIONS OF SALE.

5. LIMITATION OF REMEDY AND LIABILITY

THE SOLE AND EXCLUSIVE REMEDY FOR BREACH OF ANY WARRANTY HEREUNDER SHALL BE LIMITED TO REPAIR, CORRECTION OR REPLACEMENT, OR REFUND OF THE PURCHASE PRICE IN ACCORDANCE WITH SECTION 4 ABOVE.

ATLAS CONCORDE USA SHALL NOT BE LIABLE FOR DAMAGES CAUSED BY DELAY IN PERFORMANCE AND IN NO EVENT, REGARDLESS OF THE FORM OF THE CLAIM OR CAUSE OF ACTION (WHETHER BASED IN CONTRACT, INFRINGEMENT, NEGLIGENCE, STRICT LIABILITY, OTHER TORT OR OTHERWISE), SHALL ATLAS CONCORDE USA'S LIABILITY TO BUYER AND/OR ANY SUBSEQUENT TRANSFEREES EXCEED THE PRICE PAID BY BUYER FOR THE SPECIFIC GOODS PROVIDED BY ATLAS CONCORDE USA GIVING RISE TO THE CLAIM OR CAUSE OF ACTION. BUYER AND ANY SUBSEQUENT TRANSFEREE AGREES THAT IN NO EVENT SHALL ATLAS CONCORDE USA'S LIABILITY

PRODUCT FINDER >

PRODUCTS >

PRO RESOURCES >

TECHNICAL SPECIFICATIONS >

- Installation Methods
- Technical Information
- Trims Tiles
- Environmental Sustainability
- Certifications
- Technical Specifications
- Color Shading
- Tile Packaging
- Merchandising Packaging
- General Sales Conditions

General Sales Conditions

TO BUYER AND/OR ANY SUBSEQUENT TRANSFEREES EXTEND TO INCLUDE INCIDENTAL, CONSEQUENTIAL OR PUNITIVE DAMAGES.

The term "consequential damages" shall include, but not be limited to, loss of anticipated profits, loss of business opportunity, business interruption, loss of use or revenue, cost of capital or loss or damage to property or equipment.

It is expressly understood that any technical advice furnished by Atlas Concorde USA with respect to the use of the Goods is given without charge, and Atlas Concorde USA assume no obligation or liability whatsoever for the advice given, or results obtained, all such advice being given and accepted at Buyer's own risk.

6. EXCUSE OF PERFORMANCE

Atlas Concorde USA shall NOT be liable for delays in performance or for non-performance due to acts of God; acts of Buyer; war; fire; flood; weather; sabotage; strikes or labor disputes; civil disturbances or riots; governmental requests, restrictions, allocations, laws, regulations, orders or actions; unavailability of or delays in transportation; default of suppliers; material fluctuations in the exchange rate between the U.S. Dollar and Euro; or unforeseen circumstances or any events or causes beyond Atlas Concorde USA's 's reasonable control. Deliveries or other performances may be suspended for an appropriate period of time or cancelled by Atlas Concorde USA upon notice to Buyer in the event of any of the foregoing, but the balance of the Agreement shall otherwise remain unaffected as a result of the foregoing.

If Atlas Concorde USA determines that its ability to supply the total demand for the Goods, or to obtain material used directly or indirectly in the manufacture of the Goods, is hindered, limited or made impracticable due to causes set forth in the preceding paragraph, Atlas Concorde USA may allocate its available supply of the Goods or such material (without obligation to acquire other supplies of any such Goods or material) among its purchasers on such basis as Atlas Concorde USA determines to be equitable without liability for any failure of performance which may result therefrom.

7. CANCELLATION

Buyer may cancel orders only upon reasonable advance written notice and upon payment to Atlas Concorde USA of Atlas Concorde USA's cancellation charges which include, among other things, all costs and expenses incurred, and to cover commitments made by Atlas Concorde USA and a reasonable profit thereon. Atlas Concorde USA's determination of such cancellation charges shall be conclusive. PROVIDED, HOWEVER, THAT ANY CANCELLATION MUST BE MADE BEFORE THE GOODS HAVE BEEN SHIPPED.

8. CHANGES

Buyer may request changes or additions to the Goods consistent with Atlas Concorde USA's specifications and criteria. In the event, such changes or additions are accepted by Atlas Concorde USA, Atlas Concorde USA may revise the price and dates of delivery accordingly. Atlas Concorde USA reserves the right to change designs and specifications for the Goods without prior notice to Buyer, except with respect to Goods being made-to-order for Buyer.

9. INDEMNIFICATION

Buyer hereby covenants and agrees to defend, indemnify and hold harmless Atlas Concorde USA, their officers, directors, employees, agents, advisers, representatives and affiliates (collectively, the "Indemnitees") from and against, and pay or reimburse the Indemnitees for any and all claims, liabilities, obligations, losses, fines, costs, royalties, proceedings, deficiencies or damages (whether absolute, accrued, conditional or otherwise and whether or not resulting from third party claims), including out-of-pocket expenses and reasonable attorneys' and accountants' fees incurred in the investigation or defense of any of the same or in asserting any of their respective rights hereunder (collectively, "Losses"), resulting from or arising out of: (i) Buyer's breach of any provision or covenant set forth in this Agreement, and/or (ii) Buyer's making of any representation to any third party regarding the Goods other than the limited warranty set forth in Section 4 above.

10. ASSIGNMENT

Buyer shall not assign its rights or delegate its duties hereunder or any interest herein without the prior written consent of Atlas Concorde USA, and any such assignment, without such consent, shall be void.

11. GENERAL PROVISIONS

No change, modification, rescission, discharge, abandonment, or waiver of these Terms and Conditions of Sale shall be binding upon Atlas Concorde USA unless made in writing and signed on its behalf by a duly authorized representative of Atlas Concorde USA. No conditions, usage of trade, course of dealing or performance, understanding or agreement purporting to modify, vary, explain, or supplement these Terms and Conditions of Sale shall be binding unless hereafter made in writing and signed by the party to be bound, and no modification or additional terms shall be applicable to this Agreement by Atlas Concorde USA's receipt, acknowledgment, or acceptance of purchase orders, shipping instruction forms, or other documentation containing terms at variance with or in addition to those set forth herein. No waiver by either party with respect to any breach or default or of any right or remedy, and no course of dealing, shall be deemed to constitute a continuing waiver of any other breach or default or of any other right or remedy, unless such waiver be expressed in writing and signed by the party to be bound. All typographical or clerical errors made by Atlas Concorde USA in any quotation, acknowledgment or publication are subject to correction.

12. SEVERABILITY

If any provision of this Agreement shall be held invalid or unenforceable by competent authority, such provision shall be construed so as to be limited or reduced to be enforceable to the maximum extent compatible with the law as it shall then appear. The total invalidity or unenforceability of any particular provision of this Agreement shall not affect the other provisions hereof and this Agreement shall be construed in all respects as if such invalid or unenforceable provision were omitted.

13. GOVERNING LAW AND JURISDICTION

This Agreement shall be governed by and construed in accordance with the laws of the State of Tennessee without reference to its conflicts of laws principles. Buyer and Atlas Concorde USA agree to submit all disputes arising out of or in connection with this Agreement to the exclusive jurisdiction of the State and Federal courts of the State of Tennessee, located in Williamson County. EACH PARTY TO THIS AGREEMENT ACKNOWLEDGES AND AGREES THAT ANY CONTROVERSY WHICH MAY ARISE UNDER THIS AGREEMENT IS LIKELY TO INVOLVE COMPLICATED AND DIFFICULT ISSUES, AND, THEREFORE, EACH SUCH PARTY HEREBY IRREVOCABLY AND UNCONDITIONALLY WAIVES ANY RIGHT SUCH PARTY MAY HAVE TO A TRIAL BY JURY IN RESPECT OF ANY LITIGATION DIRECTLY OR INDIRECTLY ARISING OUT OF OR RELATING TO THIS AGREEMENT, OR THE BREACH, TERMINATION OR VALIDITY OF THIS AGREEMENT, OR THE TRANSACTIONS CONTEMPLATED BY THIS AGREEMENT. EACH SUCH PARTY CERTIFIES THAT THEY HAVE NOT RELIED UPON ANY REPRESENTATION OR INDUCEMENT OF THE OTHER PARTY IN AGREEING TO THIS PROVISION AND THAT THEY FREELY, KNOWINGLY AND VOLUNTARILY WAIVE THEIR RIGHT TO A JURY TRIAL. The Convention for the International Sale of Goods shall not apply to this Agreement.

14. U.S. EXPORT CONTROL REGULATIONS

All Goods sold to Buyer are subject to the export control laws of the United States and Buyer agrees not to re-sell or divert any Goods contrary to such laws.

15. RETURNED GOODS

Any and all material which Buyer desires to return and which Seller agrees to take back will be accepted only with prior written authorization and must be in full compliance of this Seller's return policy. No returns will be accepted on discontinued or not 1st grade material. Returns will not be accepted unless the Company has first issued a return authorization number. Only Company's Customer Service Department can authorize a return, and all return authorizations must be in writing. No sales representative may accept the return of any products without such written authorization. Products may be returned to the Company only after inspection by the Company and after receipt by the Customer of shipping instructions. Returns will be charged a minimum restocking charge of 25% (unless the Company erred in filling the order) and will be limited to full and unopened cartons that have not been damaged or mutilated in any way. Shipping, handling, insurance, taxes, risk of loss and tariff charges for return products shall be borne by Customer.

16. NO THIRD-PARTY RIGHTS

These Terms and Conditions of Sale create no third-party rights between Atlas Concorde USA and any person other than Buyer, including but not limited to any Subsequent Transferee. It is understood and agreed that the parties do not intend that any third party be a beneficiary of these Terms and Conditions of Sale.

Atlas Concorde USA reserves the right to modify any product without notice and will not be liable for any direct or indirect damage resulting from such modifications. Colors and optical features of the materials illustrated in this catalogue are to be regarded as mere indications. For information and details relating to codes, packaging and weight it is recommended to refer to the latest pricelist.

© Copyright Atlas Concorde USA, Inc. 2023 - The reproduction of the work, fully or in part, is strictly forbidden.

Notes

Atlas Concorde USA has the right to modify any product without notice and will not be liable for any direct or indirect damage resulting from such modifications.

Colours and optical features of the materials illustrated in this catalogue are to be regarded as mere indications.

For information and details relating to codes, packaging and weight it is recommended to refer to the latest pricelist.

Ceramic products can have slight variations in tone. Check with the sales representative for the possibility of combining production lots, formats, decorations and special pieces.

The production sizes of special pieces in porcelain tiles may vary from the nominal sizes provided for in current standards (ISO 13006 - EN 14411 Annex G) for non-modular tiles.

The actual dimensions of the special pieces and the smaller pieces obtained by cutting porcelain tiles could deviate from the tolerances in the catalog, which instead for the rectified formats are guaranteed by Atlas Concorde.



Installation Methods

Technical Information

Trims Tiles

Environmental Sustainability

Certifications

Technical Specifications

Color Shading

Tile Packaging

Merchandising Packaging

General Sales Conditions



Atlas ConcordeUSA, Inc.
117 Seaboard Ln - Suite F170
Franklin, TN 37067

atlasconcordeusa.com

© Copyright 2024 Atlas Concorde USA, Inc.
June 2024



atlasconcordeusa.com